

Installation Guide

Network Camera Indoor Use Only

Please read this document before using the product, and save this document for future reference.

Panasonic Network Camera Website:

<http://panasonic.co.jp/pcc/products/en/netwcam/>

• This document can be found on the included CD-ROM. English, French, German, Italian, Spanish, Russian, Simplified Chinese, and Korean versions are included.

Model No. **BB-HCM580** (AC Adaptor Type)
BB-HCM581 (PoE Ready)

This manual is written for both the BB-HCM580 (AC Adaptor Type) and the BB-HCM581 (PoE Ready). Available features and operations vary slightly depending on the model. You can confirm the model no. of your camera by checking the model no. printed on the front of the camera.

Please read the included Important Information before proceeding.

Complete Operating Instructions and all other documentation can be found on the included CD-ROM.

- This document (Installation Guide) explains how to physically connect the camera to the power supply and network, as well how to mount or place the camera for regular use.
- The **Setup Guide** describes how to set up the camera so that it can be accessed using a PC.
- Refer to the **Operating Instructions** on the **CD-ROM** for details regarding the camera's features.
- Refer to the **Troubleshooting Guide** on the **CD-ROM** if you have any problems configuring or using the camera.

Abbreviations

- UPnP is the abbreviation for "Universal Plug and Play".
- The Network Camera is referred to as "the camera" in this document.
- The Setup CD-ROM is referred to as "the CD-ROM" in this document.





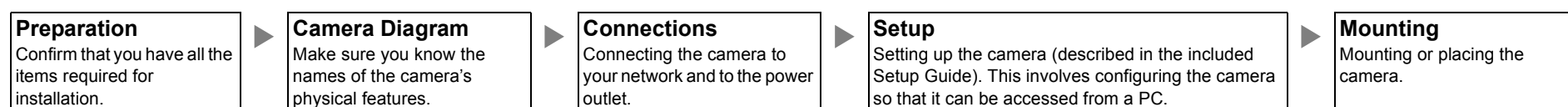



Installation Procedure Overview

The following is an overview of the steps required to install and setup the camera. All steps are explained in this document unless otherwise noted.



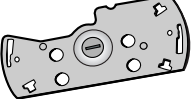
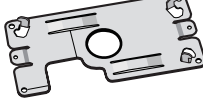

Preparation

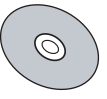
1. Confirm the following items are included in the camera's packaging.

	Main Unit (1 pc.)		Washer S (1 pc.) Order No. XWG26D12VW Used when securing the safety wire to the camera.
	Washer L (1 pc.) Order No. XWG4F16VW Used when securing the safety wire to the ceiling.		Screw A (2 pcs.) Order No. XYN3+J6FJ Used to secure ceiling plate A to ceiling plate B.
	Screw B (5 pcs.) Order No. XTB4+20AFJ Used to secure ceiling plate B (4 pcs.) and the safety wire (1 pc.) to the ceiling.		Screw C (1 pc.) Order No. PQHV2610PJ65 Used for connecting the safety wire to the camera.
	Ceiling Mounting Cover (1 pc.) Order No. PSKL1023Y2 Used when mounting the camera on a ceiling.		Ceiling Plate A (1 pc.) Order No. PQZMHCM581A Used to secure the camera to ceiling plate B.
	Ceiling Plate B (1 pc.) Order No. PQMD10110Z Used to secure the camera to the ceiling.		Safety Wire (1 pc.) Order No. PQME10080Z Used to secure the camera when mounting it.
	Important Information (1 pc.) Installation Guide (this document) (1 pc.) Setup Guide (1 pc.)		Setup CD-ROM (1 pc.) Order No. PQQX15811XCD Contains the Setup Program needed to configure the camera, as well as the camera's documentation.* *See the included Important Information for a description of each document.

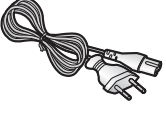
BB-HCM580 Only

	AC Adaptor (1 pc.) Order No. PQLV202T Cord Length: About 3 m		AC Cord A (1 pc.) Order No. PFJA02A006Z Cord Length: About 1.8 m For use in countries/areas other than the United Kingdom
	AC Cord B (1 pc.) Order No. PSJA1106Z Cord Length: About 1.8 m For use in the United Kingdom		

BB-HCM581 Only

	Audio/Video Cord (1 pc.) Order No. PSJA1103Y
---	---

2. You will need the following additional items to install and configure the camera.



- a PC (see the system requirements in the Important Information document)
- a router
- a LAN cable (CAT-5 straight cable)

Option for BB-HCM581

You can also connect the camera using the optional Panasonic BB-HCA3CE or BB-HCA3E AC adaptor. The optional AC adaptor includes the following items.

BB-HCA3CE: For use in countries/areas other than the United Kingdom

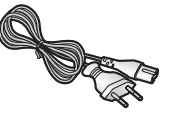
BB-HCA3E: For use in the United Kingdom

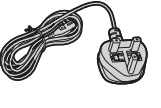
	AC Adaptor (1 pc.) Cord Length: About 3 m		AC Cord (1 pc.) Cord Length: About 1.8 m
	AC Adaptor (1 pc.) Cord Length: About 3 m		AC Cord (1 pc.) Cord Length: About 1.8 m

Camera Diagram

Front View

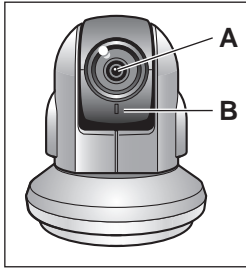

- A Lens
- B Indicator*1

Bottom View

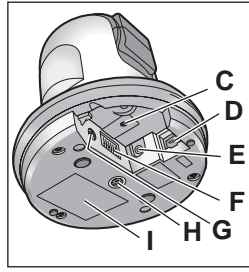

- C FACTORY DEFAULT RESET button
- D LAN port
- E DC IN jack
- F External I/O interface
- G **BB-HCM580**: Video terminal
- BB-HCM581**: Audio/Video terminal
- H Ceiling plate A hole
- I Serial number and MAC address label

Rear View

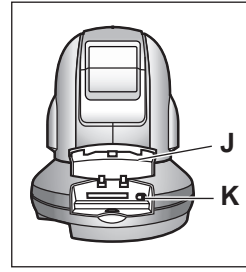

- J SD memory card cover
- K FUNCTION button/indicator

*1 See 1.1 Understanding the Camera Indicator in the Troubleshooting Guide on the CD-ROM for indicator meaning.

Connections

Before proceeding, confirm that your PC is connected to your router and can access the Internet. Also confirm that your router's UPnP™ feature is enabled. (Most routers have UPnP™ turned off by default.) Refer to the operating instructions included with your router or to the Panasonic Network Camera website (<http://panasonic.co.jp/pcc/products/en/netwcam/>) for more information.

When connecting the camera using the AC adaptor

Follow these instructions when connecting a BB-HCM580, or when connecting a BB-HCM581 using the optional AC adaptor. Connect the camera to your router and the power outlet as described below.

- **BB-HCM580 only**: Use only the included Panasonic AC adaptor and AC cord.
- **BB-HCM581 only**: If using an AC adaptor, use the appropriate optional Panasonic AC adaptor; model no. BB-HCA3CE (for use in countries/areas other than the United Kingdom), or model no. BB-HCA3E (for use in the United Kingdom).

- 1 Connect the LAN cable to the camera and the router.
- 2 Connect the AC adaptor cord to the DC IN jack.
- 3 Connect the AC cord to the AC adaptor, then plug the AC cord into the power outlet.
 - The lens will pan and tilt when the camera is turned on.
 - Confirm that the indicator lights green after about 1 minute. If the indicator does not light green, see 1.2 Camera Indicator Issues in the Troubleshooting Guide on the CD-ROM.



- When you operate the camera, the power outlet should be near the camera and easily accessible.
- When the lens pans or tilts, a sound can be heard from the camera. This is normal.

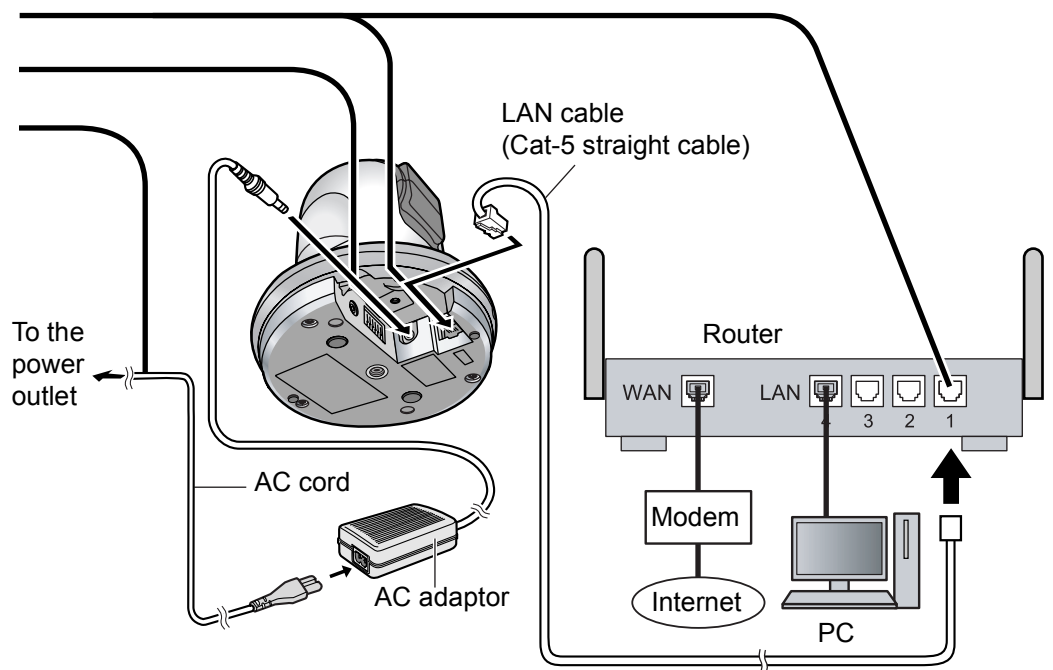

When connecting the camera using PoE (Power over Ethernet) (BB-HCM581 Only)

Connect the camera to your PoE hub using a LAN cable (Cat-5 straight cable) as described below.

- 1 Connect a LAN cable to the camera and to the PoE hub.
 - Your PoE hub must be connected to the router. Refer to the operating instructions included with the PoE hub for connection instructions.
 - The lens will pan and tilt when the camera is turned on.
- 2 Connect a LAN cable to a LAN port of the PoE hub and to a LAN port of the router.
 - Confirm that the indicator lights green after about 1 minute. If the indicator does not light green, see 1.2 Camera Indicator Issues in the Troubleshooting Guide on the CD-ROM.



- When the lens pans or tilts, a sound can be heard from the camera. This is normal.
- Use a 4-pair UTP/STP cable.
- Do not use a relay connector or a hub between the camera and the PoE hub. These devices may disturb the data or electricity transmission.
- If the PoE hub has indicators, the indicator lights as shown in the table below.

Indicator	Description
LINK	Turns on when the data is transmitted from the camera.
PoE	Turns on when the electricity is supplied to the camera.

- If the PoE hub is turned off or power supply is temporarily cut off by the disconnection of the LAN cable, it may take time for the PoE hub's indicators to light.
- The indicator display differs depending on manufacturers, refer to the manuals of the PoE hub.

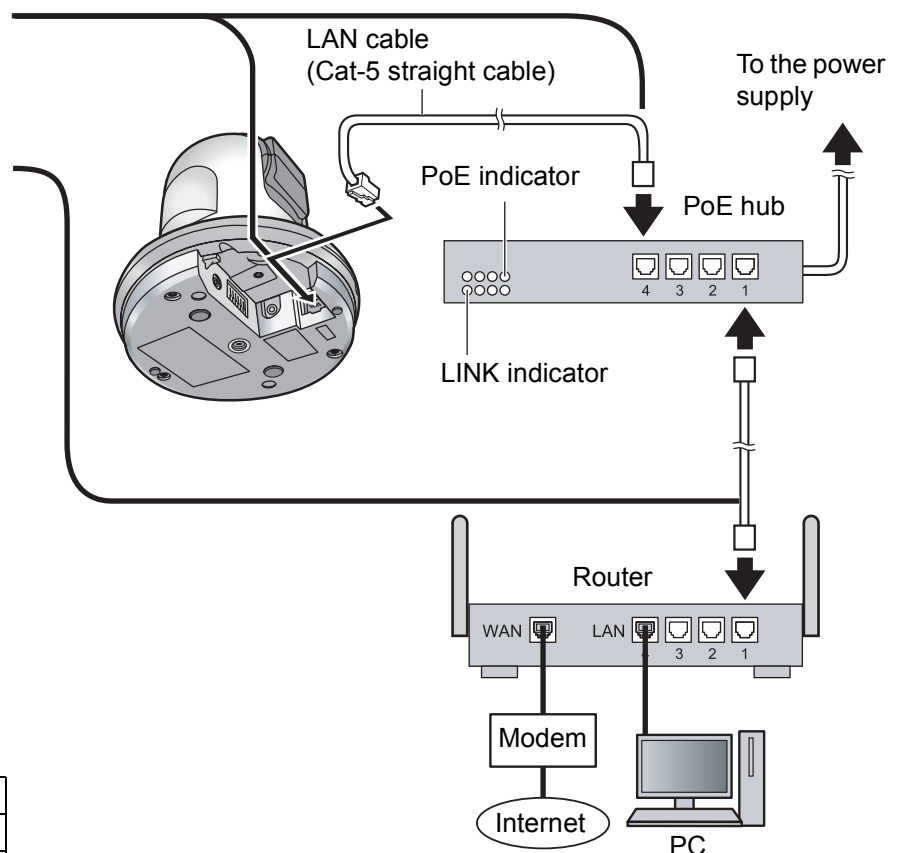

After the camera's indicator turns green, you may set up the camera. Continue by following the procedure described in the included Setup Guide.

- If the indicator does not turn green, see 1.2 Camera Indicator Issues in the Troubleshooting Guide on the included CD-ROM.

Read the following information after setting up the camera according to the procedure described in the Setup Guide.

Connecting External Sensors

The camera's external I/O interface allows you to connect 2 devices (such as sensors, motion detectors, etc.) that can be used to trigger the camera's image buffering and transferring features (see Section 2 Using Triggers to Buffer and Transfer Images in the Operating Instructions on the CD-ROM). The external I/O interface has 6 terminals.

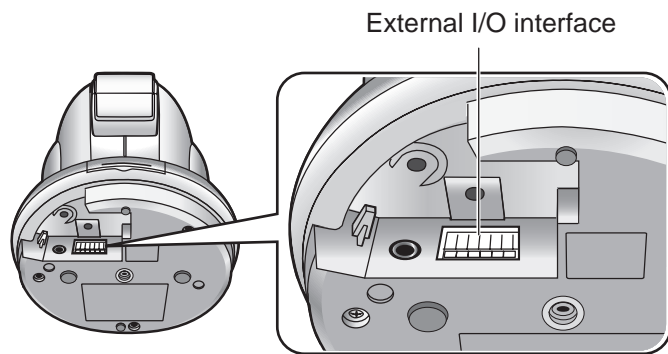

Terminal	Description
G	GND terminal.
1	External sensor input 1. The camera can be triggered by either an open circuit or a GND short-circuit.
G	GND terminal.
2	External sensor input 2. The camera can be triggered by either an open circuit or a GND short-circuit.
3	External device control output. Allows you to control an external device using the output buttons in the camera's operation bar (for example, turning a light on or off). <ul style="list-style-type: none"> This terminal's behavior can be changed (see 7.4 Controlling the External Output Terminal in the Operating Instructions on the CD-ROM). This terminal is an open collector circuit. The maximum drawing current is the same as terminal 4. Do not exceed the voltage of the terminal 4.
4	DC power output terminal. <ul style="list-style-type: none"> 10.5–13 V DC Maximum load drive is 100 mA.

Note

- Do not push strongly on the external I/O interface with the pointed object. The external I/O interface may get stuck into the unit, and you may not be able to use it.

Circuit Diagram Example

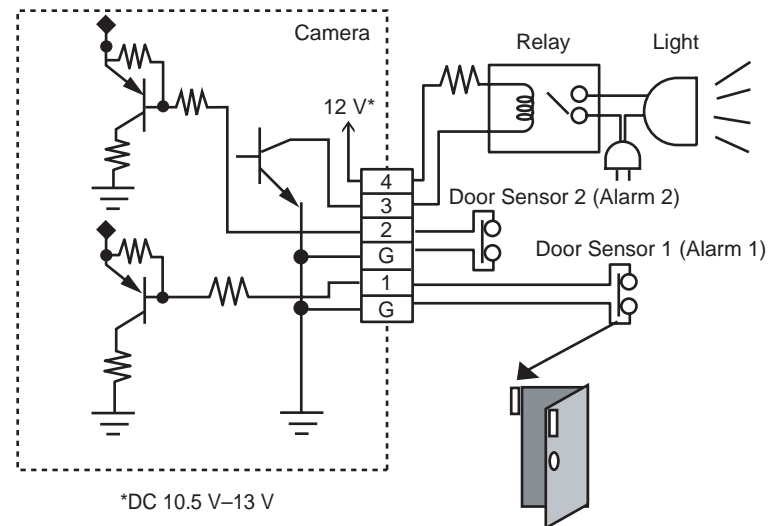

Caution

- The external I/O interface is not capable of connecting directly to devices that require large amounts of current. In some cases, a custom interface circuit (customer-provided) may have to be used. Serious damage to the camera may result if a device that exceeds its electrical capability is connected to the external I/O interface.
- Low voltage/current circuits and high voltage/current circuits are used in the camera circuit. All wiring should be performed by a qualified electrician. Incorrect wiring could damage the camera and cause a fatal electric shock.
- External devices connected to the camera's output terminals cannot be controlled in the event of a network error or failure. Keep this in mind when connecting door locks, heat-emitting devices, or other devices that may be dangerous if they cannot be controlled.

Connecting a Video Device (BB-HCM580 Only)

You can connect a TV or other video device (NTSC or PAL format) to the camera to monitor or record camera images. Connect the video device as shown below.

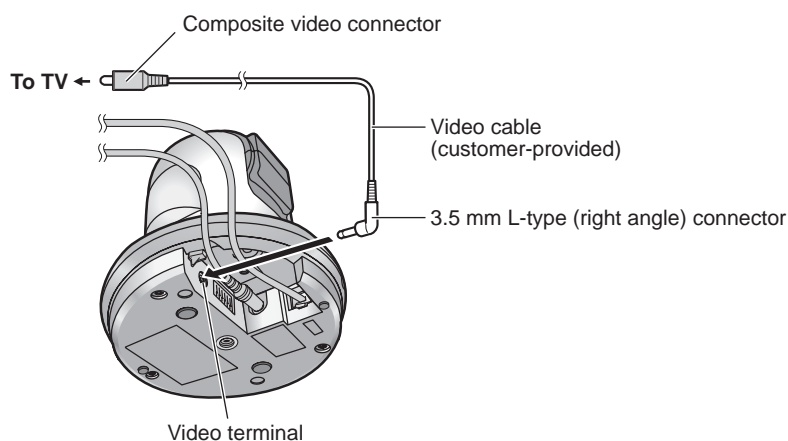

Connecting Audio/Video Devices (BB-HCM581 Only)

You can connect an external microphone and external speaker to the camera to use the Listen and Talk features, respectively. For information about these features, see 1.2.10 Audio Features in the Operating Instructions on the CD-ROM. You can also connect a TV or other video device (NTSC or PAL format) to the camera to monitor or record camera images. Connect the devices as shown below.

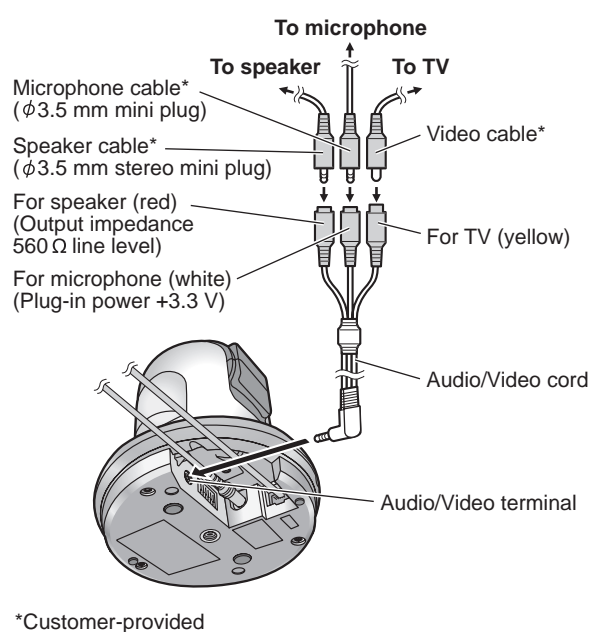

Note

- Analog video output is disabled by default. See 7.5 Controlling the Analog Video Output Signal in the Operating Instructions on the CD-ROM for more information.
- If you use an external microphone, excessive cable length or a poor quality cable can cause degradation in audio quality.
- The microphone cable should be no longer than 7 m.
- Use a speaker with a built-in amplifier. The speaker connects to the camera with a stereo audio cable similar to that used by your PC. The output signal is mono.
- Make sure the camera and speaker are turned off when connecting or disconnecting the speaker cable, otherwise noise may be heard from the speaker.
- The external microphone input does not correspond to a line level. Audio may be distorted when the line level is input. Audio distortion will be solved if you insert the following circuits. Under no circumstance should high-level audio, such as from a speaker, be connected to this input terminal. Doing so is likely to damage the camera.

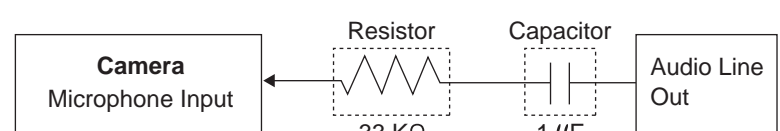

Important Information Regarding Camera Mounting

The camera can be mounted on a ceiling or table. Please read the following information before mounting the camera. Consult an authorized dealer for mounting.

Caution

- Make sure you attach the safety wire when mounting the camera on a ceiling to prevent the camera from falling.

Note

- The camera is intended for indoor use only and should not be mounted outdoors.
- Use screws that are appropriate for the material of ceiling.
- The included screws are for use with wooden ceilings only.
- To ensure that camera images are displayed properly, do not mount the camera on an incline. Mount the camera so that it is perpendicular to the floor.
- When the camera is mounted on a ceiling, the ceiling mounting cover must be removed in order to insert or remove the SD memory card.
- The camera's MAC address and serial number are printed on the bottom of the camera and are needed in order for camera configuration and maintenance. Make a note of both of them for before mounting the camera.
- Mounting and cabling instructions described in this document follow generally accepted guidelines suitable for residential installations. In some areas, commercial and industrial installations are regulated by local or state ordinances. For such installations, contact your local building department or building inspector for more details.
- Camera images can be viewed in relatively dark areas, however, image quality decreases when viewing dark images. We recommend using supplemental lighting for best results.
- Prolonged exposure to direct sunlight or halogen light may damage the camera's image sensor. Mount the camera appropriately.
- When mounting the camera, make sure to wrap the AC adaptor cord (if used) and other cables (external microphone or speaker cable, video cable, etc.) around the hooks as shown to ensure secure connections.

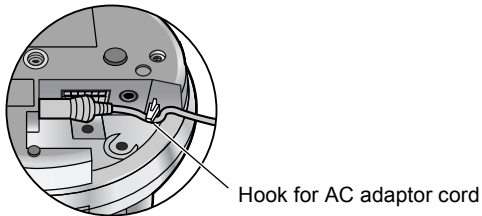

Mounting the Camera on a Ceiling

1. Access the camera and set the [Mounting Type] setting to [On the ceiling] (see 5.4 Changing Basic Camera Settings in the Operating Instructions on the included CD-ROM). The camera lens will change direction as shown below.

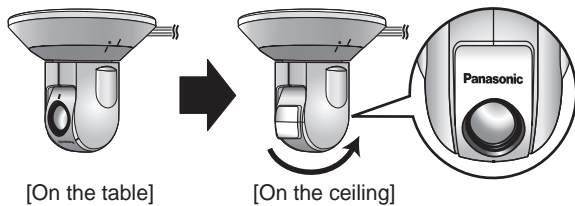

2. Secure the safety wire to the camera using screw C (included) and washer S (included).
 - Make sure you attach the safety wire when mounting the camera on a ceiling to prevent the camera from falling.

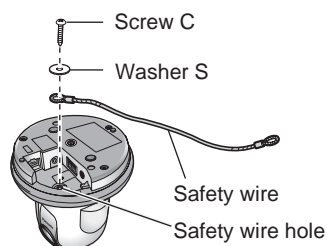

3. Attach ceiling plate A (included) to the camera by aligning it as shown. Secure the plate to the camera firmly.

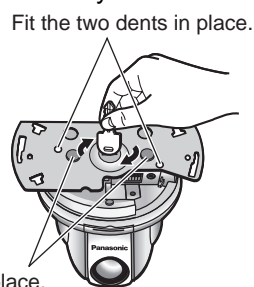

4. Secure ceiling plate B (included) to the ceiling using screws B (included).
 - Make sure there is at least 100 mm of space, with no obstacles, from the center of the plate.
 - Do not drive the screws into a soft material. Drive the screws into a secure, 25 mm thick area of the ceiling, such as a crossbeam, otherwise the camera may fall. If there is no crossbeam, place a board on the other side of the ceiling to make sure the camera is securely mounted.

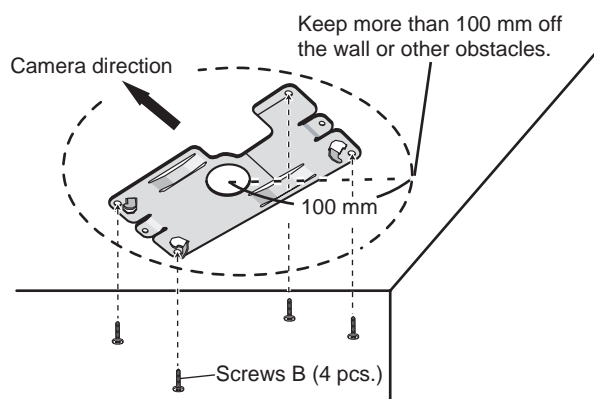

5. If you plan to run the cables above the ceiling, make a 30 mm hole in the ceiling, as shown. Run all necessary cables (AC adaptor, LAN, audio/video, etc.) through the hole.

- The center of the hole should be at the point where the 2 lines on ceiling plate A would intersect, as shown.

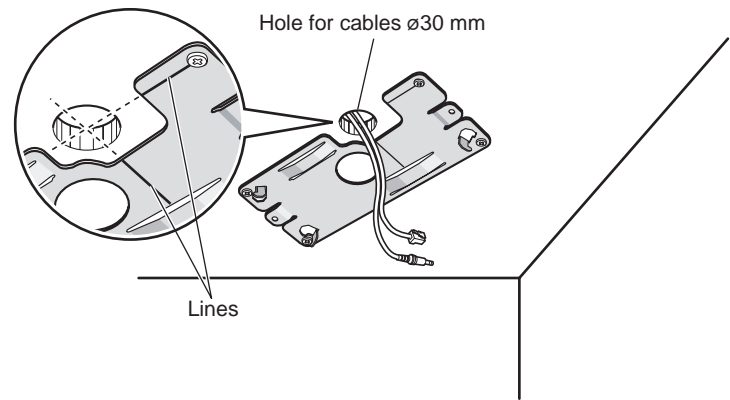

6. Connect all necessary cables (AC adaptor, LAN, audio/video, etc.).
7. Attach ceiling plate A to ceiling plate B by aligning the 3 tabs as shown, then turning ceiling plate A counterclockwise until the tabs are secured. Secure the plates using screws A (included).

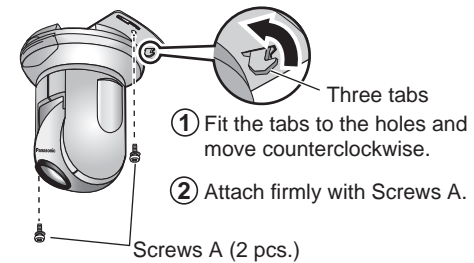

- The camera should be mounted so that the SD memory card cover faces the front of the camera (i.e., the same direction as the lens).
8. Attach the ceiling mounting cover by first aligning the "I" mark on the camera and cover, then turn the cover clockwise until the "I" mark on the camera and the "o" mark on the cover are aligned as shown.

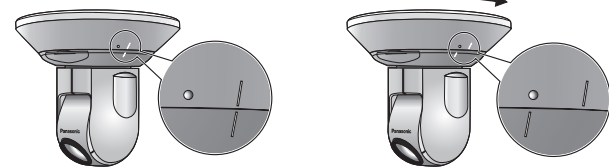

- Be careful not to nip the cable etc.
- When removing the Ceiling Mounting Cover, move it in the counterclockwise direction. Adjust both "I" and let down the main unit.
- If you did not make a hole in the ceiling for the cables, remove the tab on the ceiling mounting cover and pass the cables through the opening as shown.



9. Secure the safety wire to the ceiling using screw B (included) and washer L (included).
 - Secure the safety wire to the ceiling about 100 mm from the center of ceiling plate B.
 - Do not drive the screw into a soft material. Drive the screw into a secure, 25 mm thick area of the ceiling, such as a crossbeam, otherwise the camera may fall. If there is no crossbeam, place a board on the other side of the ceiling to make sure the camera is securely mounted.

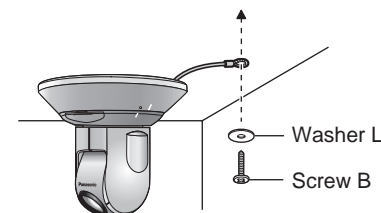

When mounting the camera on a concrete or mortar ceiling

1. Place ceiling plate B against the ceiling and mark the points where you are going to make holes.
2. Make holes with an electric drill. Insert anchors (customer-provided) into the holes and push them inside the holes with a hammer.
 - Mortar ceilings break easily when drilling. Be careful of pieces of mortar which may become loose and fall.

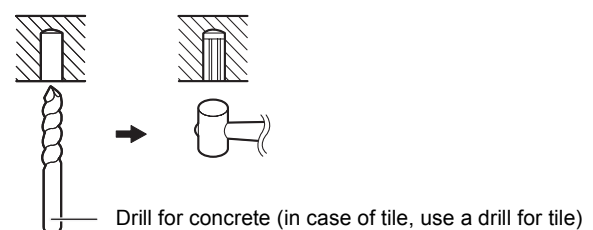

3. Mount the camera by following the instructions on this page.

Mounting the Camera on a Table

Mount or place the camera on a secure and even surface where there are few vibrations.

