



DynaHawk™ 701/801 Series

Integrated High Speed Dome Camera



A Precise Check in a Snap

Features

PRECISE AND ACCURATE TRACKING

- New** Scheduling Functions
- Preset speed up to 400°/sec
- Pan driver accuracy of 0.225°
- Pan & Tilt proportional to Zoom Ratio
- Preset Position/Pan/Sequence/Cruise/Turn-Around
- Auto Calibration

DAY/NIGHT FEATURES

- Removable IR Cut Filter

LOW-LIGHT APPLICATIONS

- Minimum illumination 0.01 Lux
- Digital Slow Shutter
- Electronic Shutter

PERFECT CONTRAST SOLUTIONS FOR HIGH IMAGE QUALITY

- Wide Dynamic Range
- Auto White Balance
- Backlight Compensation
- Auto Exposure

MULTIPLE BUILT-IN PROTOCOLS ENHANCED HIGH COMPATIBILITY

- DynaColor
- Pelco D & P
- VCL
- Philips
- AD485
- AD422 (Manchester)

PRIVACY MASK FOR PRIVACY PROTECTION

- Up to 24 masking zones

DYNAMIC DOME CONFIGURATION

- Flexible Indoor/outdoor mountings
- Compact lightweight design for easy installation
- Weather resistant housing

INTEGRATED WITH WEB, ENABLED INTERNET CAPABILITY

- Remote Monitoring/System Configuration/Software Upgrade
- Include Window active applications

The Integrated High Speed Dome Camera can be fully integrated with our entire line of products: DVRs, Control Keyboards, and CCTV accessories, for a low-maintenance CCTV surveillance system from one reliable manufacturer. In addition, a large set of built-in protocols provide connectivity to other brand products of CCTV surveillance systems, including DynaColor, Pelco, VCL, Philips, AD-Manchester, AD-422, etc.

System Configuration

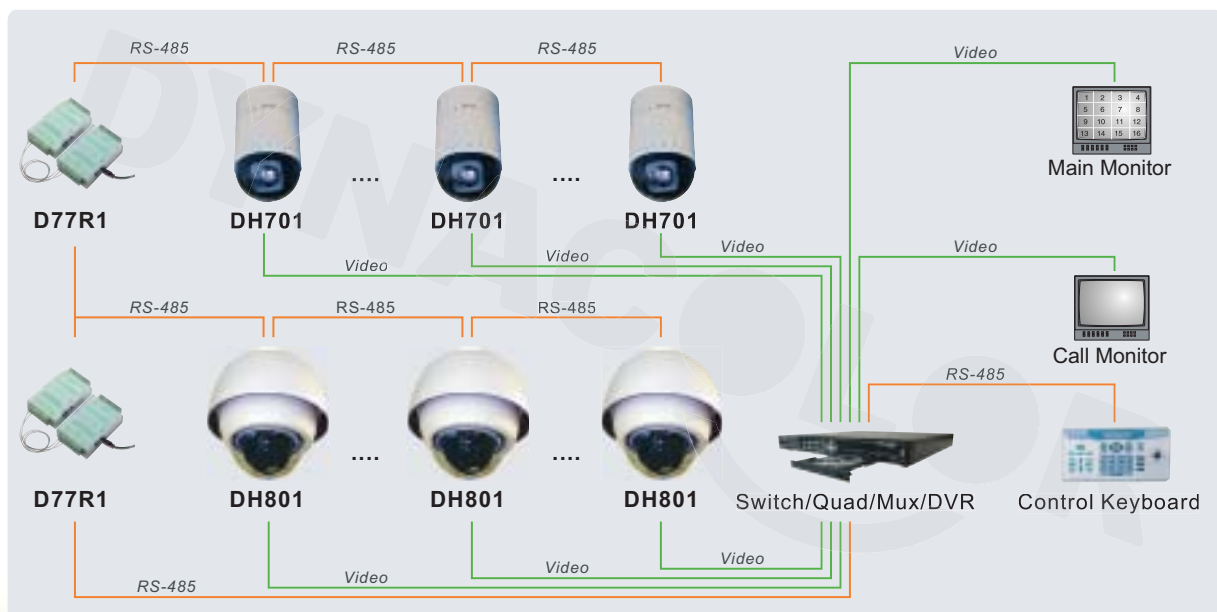

Integrated High Speed Dome Cam

Digital Image Flip

One of the main features of the Integrated High Speed Dome Camera, can reverse the image through the digital processing without interruption while tracking the object passing directly beneath the dome.

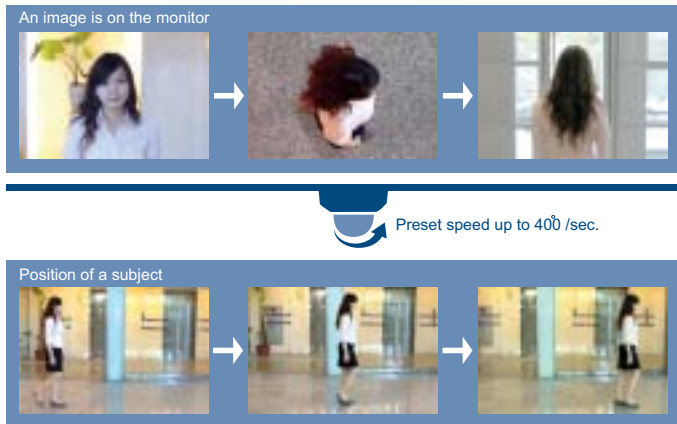

Advanced Features Remedy the Environmental Factors

The Integrated High Speed Dome Camera is easily configurable to capture images clearly without distortion in spite of changes in environment. Digital Slow Shutter and Electronic Shutter functions are designed to solve low-light environmental issues. Auto White Balance, Back Light Compensation, Auto Iris Control, and Auto Gain Control functions ensure sharp images under the environmental condition of high-contrast or backlight.

Privacy Masking Function

Allows users to mask selected areas that are protected to avoid any intrusive monitoring.

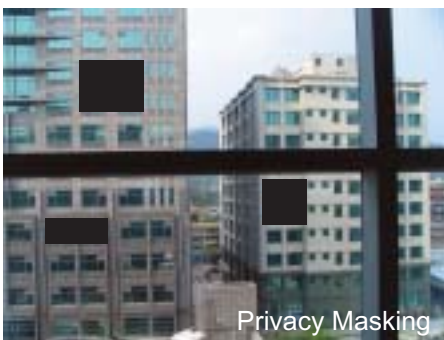

Persist and Accurate Tracking

The Integrated High Speed Dome Camera provides variable pan/tilt speed, ranging from a fast patrol of 400° per second to slow ramble of 0.5 per second. With the enhanced pan driver accuracy of 0.225° and tilt driver accuracy of 0.45° it enables users to track distant subjects more accurately. With the Auto Calibration function, the dome camera calibrates automatically when the deviation of dome pivot is detected. The Integrated High Speed Dome is the perfect solution for various surveillance applications; such as Airports, Supermarkets, Casinos, Gyms, and Train Stations , etc.

Wide Dynamic Range (WDR) Function

Enables the dome to catch detailed information from the dark part without any saturation from the bright part, and improves image quality and video performance under simultaneous indoor and outdoor light conditions.

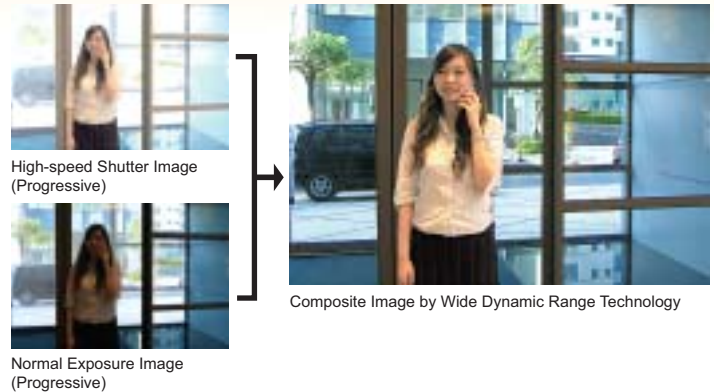

Day/Night Function

The IR Cut Filter can be automatically or manually removed, depending on light conditions, enables the camera to capture color video in light conditions down to 0.7 lux, and black and white video in conditions down to 0.001 lux.

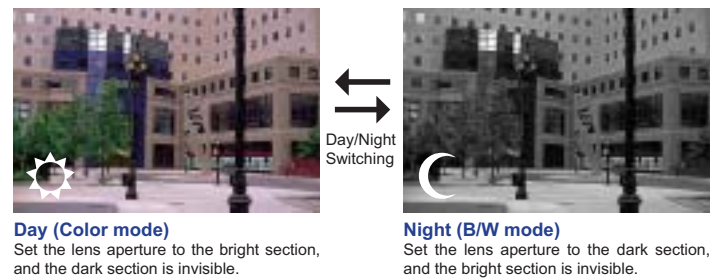

Motion Detection Function

Enables the Integrated High Speed Dome Camera to output an alarm signal or activate a particular function when a moving object is detected within the monitoring area.



Special Functions Meet Users' Particular Needs

The Integrated High Speed Dome Camera comes with many user friendly features to meet user's particular needs and enhances better performance. Auto Pan, Cruise, Sequence, and Preset functions allow users to efficiently scan a specific route or objects. Scheduling Function allows users to set up a particular function to execute at different time. Home Position Function ensures the dome to automatically return to predetermined location defined by user after a specific time of inactivity.

Conservative design provides more purchase selections

Depending on the requirements of the application, users can refer to the following explanations, and choose a right dome that best fit each installation environment.



Various Preset Speed and Resolutions

The Integrated High Speed Dome is equipped with 2 types of superb silent motors enhance smoother rotation, and more accurate tracking, and presents various "Preset Speed" and resolutions. Standard Resolution: 768 steps/circle. High Resolution: 1600 steps/circle

D Type of Motor:

Pan: High Resolution 1600 Steps/360°
Tilt: Standard Recolution 200 Steps/360°

E Type of Motor:

Pan: High Resolution 1600 Steps/360°
Tilt: High Recolution 400 Steps/360°

IP66 Weatherproofed Housing Enabled Both Indoor and Outdoor Applications

DynaHawk™ 801 Series is compact designed and combined with a weather resistant housing which meets IP66 international standards. It can be installed under building eaves, on external walls, rooftops, etc. Additionally, sunshield housing is available to withstand the harsh weather or environment conditions.

With a full line of accessories, DynaHawk™ 801 Series are capable to accommodate any indoor and outdoor installation requirements. Users can choose from a variety of wall mounts, corner mounts, pole mounts, ceiling mounts, pendant mounts, etc. based on the installation condition for easy and efficient installations.

Installation Example

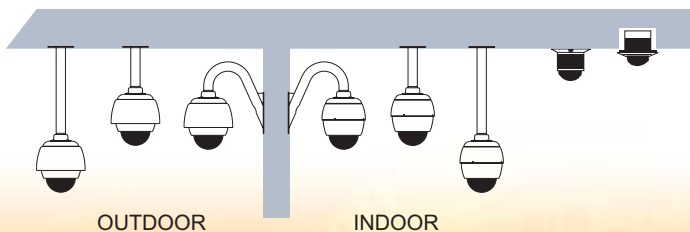

Choose a Dome

Indoor Integrated High Speed Dome Camera(DH701):

- Best choice for indoor applications
- Compact & lightweight dome (131 x 226mm, 1.6kg)
- Intelligent design for easy installation

Outdoor Integrated High Speed Dome Camera(DH801):

- For both indoor and outdoor applications
- Weather resistant housing, with IP66 certification
- Support flexible installation accessories



DH701



DH801



DH801+Sunshield

Choose a Camera

5 models of cameras are supported to satisfy user's specialized applications

R Model:

The most cost effective and simple model.

E-Model:

Motion Detecting High Speed Dome for factories, warehouse, supermarket, etc.

F-Model:

The basic Day-Night High Speed Dome for medium and small industrial applications.

K-Model:

With WDR, this can be your best choice for office building, parking, restaurant, hotel, etc.

U-Model:

The high performance High Speed Dome for large industrial applications.

| Features | R Model | E Model | F Model | K Model | U Model |
|--------------------------|---------|---------|---------|---------|---------|
| Optical Zoom | 22X | 18X | 18X | 23X | 26X |
| Digital Flip | - | Yes | Yes | Yes | Yes |
| Digital Slow Shutter | - | Yes | Yes | Yes | Yes |
| Motion Detection | - | Yes | Yes | - | Yes |
| Wide Dynamic Range | - | - | - | Yes | - |
| Day/Night: IR Cut Filter | - | - | Yes | Yes | Yes |

*For detailed specifications, please refer to Technical Specifications.





DH701 Mounting Accessories



T-Bar Ceiling Mount
 High: 170 mm (6.7 inches)
 Diameter: 180 mm (7.1 inches)
 0.5 kg (1.1 lbs)



Hard Ceiling
 High: 30 mm (1.2 inches)
 Diameter: 180 mm (7.1 inches)
 0.2 kg (0.44 lbs)

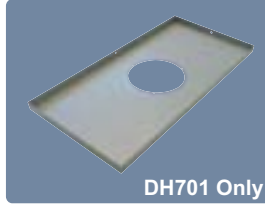

Ceiling Panel
 Zn Platted
 610x305 mm (24x12 inches)
 Diameter=135 mm (5.3 inches)



Connector Box
 White
 95x42 mm (3.7x1.7 inches)
 0.13 kg (0.3 lbs)



Transparent Cover / Smoke Cover
 Diameter: 137 mm (5.4 inches)
 127 mm (5.0 inches)

DH801 Mounting Accessories

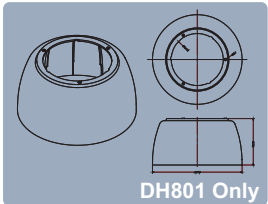

Sunshield
 White
 High: 135.5mm (5.3 inches)
 Diameter: 261.6mm (10.3 inches)
 0.3 kg (0.7 lbs)

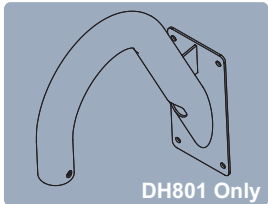

Gooseneck Tube
 White
 Iron
 298x385mm (11.73x15.16 inches)
 2.1kg (4.6 lbs)

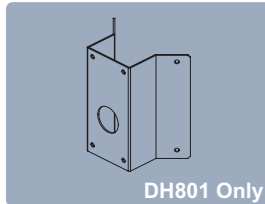

Corner Standard Mounting Plate
 222x204x117 mm (8.7x8x4.6 inches)
 2 kg (4.4 lbs)

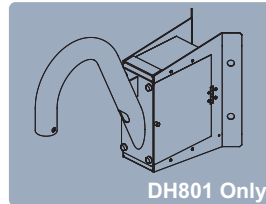

Corner Thin Box Mounting
 300x164x222 mm (11.8x6.5x8.7 inches)
 3 kg (6.7 lbs)

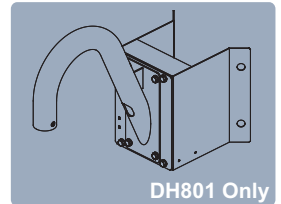

Corner Wide Box Mounting
 232x234x210 mm (9.1x9.2x8.3 inches)
 2.7 kg (6 lbs)

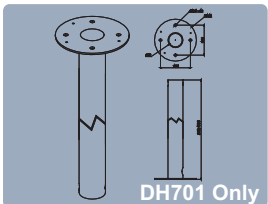

Straight Tube
 White
 Iron
 High: 250/500 mm (9.8/19.7 inches)
 Diameter=50 mm (2 inches)
 1 kg (2.2 lbs)/1.8 kg (4 lbs)

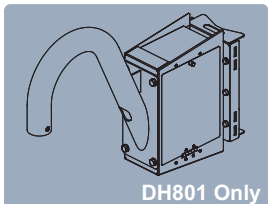

Pole Thin Box Mounting
 291x170x250 mm (11.5x6.7x9.8 inches)
 3.1 kg (6.9 lbs)

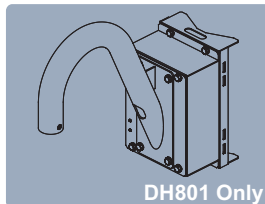

Pole Wide Box Mounting
 270x166x155 mm (10.6x6.5x6.1 inches)
 3.2 kg (7.1 lbs)

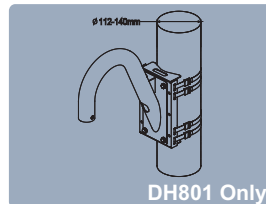

Pole Thin Direct Mounting
 232x136x60 mm (9.1x5.4x2.4 inches)
 Diameter: 112~140mm (4.4x5.5 inches)
 0.7 kg (1.6 lbs)

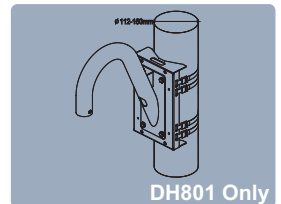

Pole Wide Direct Mounting
 270x170x60 mm (10.6x6.7x2.4 inches)
 Diameter: 112~130 mm (4.4x5 inches)
 1 kg (2.2 lbs)

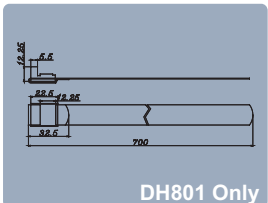

Stainless Straps
 D77H05-T02
 (Suitable for Straps Width: 1/2", 5/8", 3/4")
 0.02 kg (0.04 lbs)



Cutting Tools for Stainless Straps
 1.4 kg (3.1 lbs)



Transparent Cover / Smoke Cover
 DH801: PMMA/SMOKE/PC
 Diameter: 152 mm (6 inches)

DH701&DH801 Accessories



Power Adapter
 77H07-A1015
 Input:100~115Vac/Output:24Vac 36VA
 77H07-A2015
 Input:220~230Vac/Output:24Vac 36VA
 77H07-A1030
 Input:100~115Vac/Output:24Vac 72VA
 77H07-A2030
 Input:220~230Vac/Output:24Vac 72VA



Power Box (IP66)
 White
 186.5x147 mm (7.3x5.8 inches)
 2.6 kg (5.8 lbs)
 77H07-P1030
 Input:100~115Vac/Output:24Vac 72VA
 77H07-P2030
 Input:220~230Vac/Output:24Vac 72VA



Repeater/Converter
 D77R1:
 RS-485/RS-422 Repeater

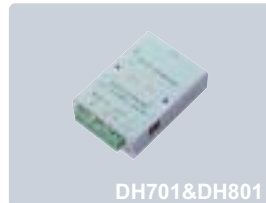

Repeater/Converter
 D77R2:
 RS-232 between RS-485/RS-422



Repeater/Converter
 D77R3:
 Bi-Phase to RS-485/RS-422

